

Manual

Software SPECTRO3-MSM-DOCAL-Scope V1.1

(PC software for Microsoft® Windows® 7, 8, 10)

for color sensors of SPECTRO-3-MSM Series

This manual describes the installation of the PC software SPECTRO3-MSM-DOCAL-Scope.

The software was developed for calibrating color sensors of the

SPECTRO-3-MSM-DIG Series
 SPECTRO-3-MSM-ANA Series
 SPECTRO-3-MSM-SLE Series and
 SPECTRO-3-MSM-SLA Series

Here, calibration takes place with a calibration wizard, which guides the user step by step through the calibration process via the corresponding instruction windows.

There are 3 preconditions

1. You need **one** reference plate. This is one of the RAL 9003-P, RAL 9010-P or RAL 9016-P plates.
2. You need different RAL color plates from the RAL CLASSIC or RAL DESIGN SYSTEM plus series. They are available from the supplier of the sensor.
3. You need a file (.ini file) in which the L*a*b* values for the various RAL plates are stored. This file is also available from the supplier (via download → RAL Plate Data Files).

After successful calibration, the sensor can be taught different surfaces (colors).

The parameters required for this are enabled on the PC interface. Other parameters, which can only be set via the respective main software, or which were permanently set during calibration, are only displayed in gray and cannot be changed.

As usual, the sensor data are visualized on the PC surface. The current color space coordinates (mostly L* a* b*) as well as their difference (delta L*, delta a*, delta b*) to a respective color hit are also displayed.

The color space coordinates as well as their deltas and two freely adjustable documentation entries can then be output to a label printer, for example.

We recommend the following label printer and accessories:

Printer	Accessories	Accessories
Company: cab Produkttechnik GmbH & Co. KG Model: cab EOS2/300 Item No. 5978202	Adhesive roll label Item No. 5780036 Material: TF Satin White Width x Height: 50x30mm	Thermal transfer ribbon Item No. 5556661

You can download drivers, documentation, additional software, etc. at the following link:

https://www.cab.de/en/marketing/label-printer/eos25/?ref=nav_lang

The installation of the software for the label printer is described in this manual.

Label printer and accessories can also be purchased from our company.

We have no experience with other printers and therefore cannot provide support.

Contents

1.	Installation of the SPECTRO3-MSM-DOCAL-Scope software	3
2.	Operation of the SPECTRO3-MSM-DOCAL-Scope software.....	4
2.1	Tab CONNECT	5
2.2	Tab PARA1, PARA2, button SEND, GET, GO, STOP	7
2.3	Tab TEACH	11
2.4	Graphical display elements	13
2.5	Tab CALIB.....	16
2.6	Tab DOCU	17
3.	Commissioning the label printer EOS2/300	18
3.1	Loading the roll adhesive label and the thermal transfer ribbon	19
3.1.1	Loading media from roll	19
3.1.2	Loading transfer ribbon.....	21
3.2	Installing the printer driver for Windows via USB cable	22
3.3	Setting the printer properties	25

Shortcuts:

SEND	F9
GET	F10
GO	F11
STOP	F12

1. Installation of the SPECTRO3-MSM-DOCAL-Scope software

The following requirements must be fulfilled for successful installation of the software:

- Microsoft® Windows® 7, 8, 10
- IBM PC AT or compatible
- VGA graphics
- Microsoft-compatible mouse
- Serial RS232 interface at the PC or USB slot or RJ45 connector
- Cable **cab-las4/PC** for the RS232 interface or **cab-4/USB** USB converter or **cab-4/ETH** Ethernet converter

Please install the software as described below:

1. You can download the software via a provided download link or, if applicable, install it via the provided software DVD. To install the software, start the 'SETUP' program in the 'SOFTWARE' folder.
2. The installation program displays a dialog and suggests to install the software in the C:\"FILENAME" directory on the hard disk. You may accept this suggestion with OK or [ENTER], or you may change the path as desired. Installation is then performed automatically.
3. During the installation process a new program group for the software is created in the Windows Program Manager. In the program group an icon for starting the software is created automatically. When installation is successfully completed the installation program displays "Setup OK".
4. After successful installation the software can be started with a left mouse button double-click on the icon.

Windows™ is a registered trademark of Microsoft Corp.
VGA™ is a trademark of International Business Machines Corp.

2. Operation of the SPECTRO3-MSM-DOCAL-Scope software

Please read this chapter first before you start calibration.

When the SPECTRO3-MSM-DOCAL-Scope software is started, the following window appears on the Windows interface:

In this case a sensor of the SPECTRO-3-MSM-DIG series is connected. For other sensors the view changes depending on the available parameters and functions.

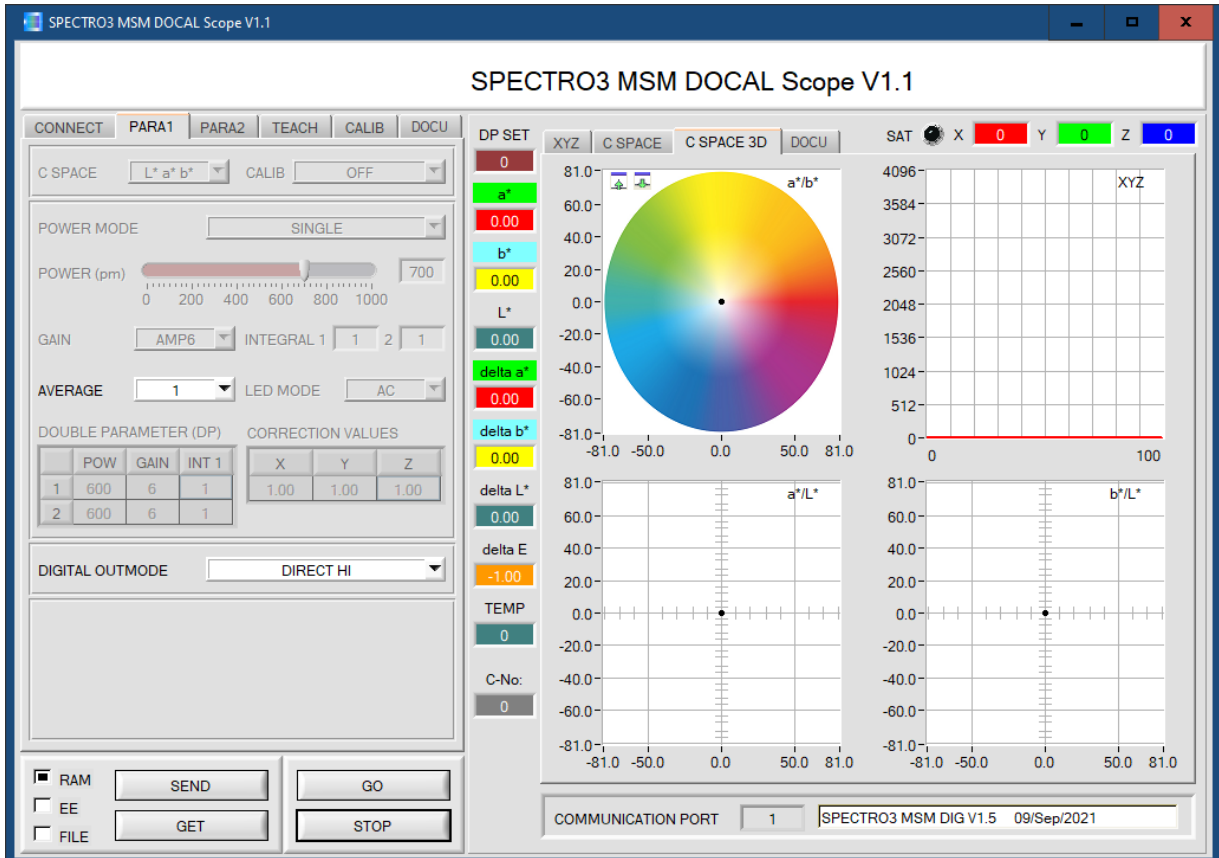

The window size and position will be the same as when the software was last closed. A double-click with the right mouse button, e.g. under the minimise symbol places the window centrally in its original size.

If a connection is not established automatically, e.g. if no sensor is connected, the software can be run in OFFLINE mode. In offline mode it only is possible to exchange parameters with a file on a storage medium, which often is helpful for the purpose of analysing parameter files.

If a sensor is connected and a connection still cannot be established, either the SCOPE version (program at the PC) and the firmware version (program in the sensor) do not match, or the interface to the sensor must be correctly configured.

If different Scope and firmware versions should be the problem, please get the Scope version that matches the firmware from your supplier.

The interface configuration is described in the CONNECT tab chapter.

Pressing the right mouse button on an individual element will call up a short help text.

Due to a better overview, parameters that are not required, displays, graphs, etc., are greyed out or invisible depending on the parameterization.

2.1 Tab CONNECT

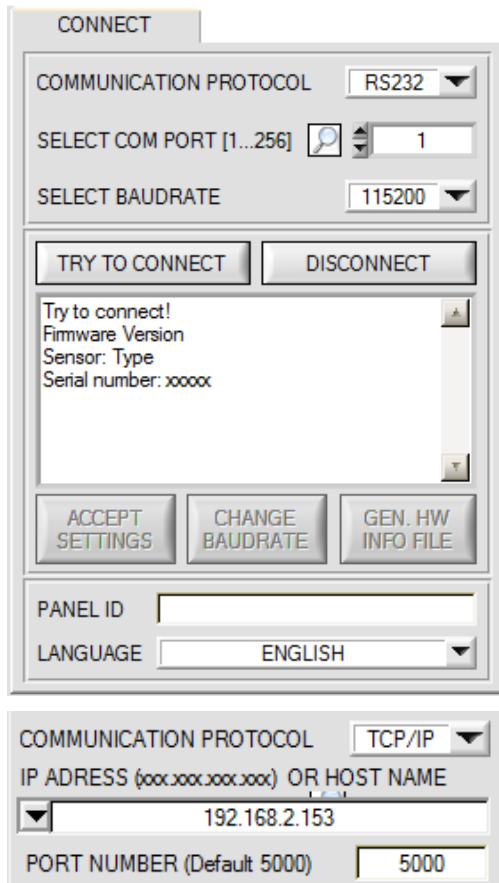

CONNECT:

Pressing the **CONNECT** tab opens a window for selecting and configuring the interface.

The **COMMUNICATION PROTOCOL** function field is used for selecting either an **RS232** or a **TCP/IP** protocol.

If **RS232** is selected, a port from 1 to 256 can be selected with **SELECT COM PORT**, depending on which port the sensor is connected to. The sensor operates with a set baudrate that can be modified with **CHANGE BAUDRATE** (see below). The sensor and the user interface both must operate with the same baudrate.

At the user interface the baudrate is set with **SELECT BAUDRATE**. If after starting the software should not automatically establish a connection, the correct baudrate can be found with **SELECT BAUDRATE**.

If an converter is used, the **COM PORT** number can be determined by way of the hardware manager in the system control panel.

A click on the magnifier symbol opens a list with all the possible COM ports in the display.

An RS232 to Ethernet converter (**cab-4/ETH**) is needed if the sensor should communicate through a local network. With this converter a connection to the sensor can be established using the **TCP/IP** protocol.

Parameterisation of the **cab-4/ETH** converter (assigning of IP address, baudrate setting, ...) can be done with the **SensorFinder software** that is available free of charge on the internet.

In order to establish a connection to the converter, its IP address or HOST name must be entered in the field **IP ADDRESS (xxx.xxx.xxx.xxx) OR HOST NAME**. The DROP DOWN menu (down arrow) shows the last 10 IP addresses that were used. An address from this list can be directly selected by clicking on the respective item. The DROP DOWN list is saved and is thus always available when the software is closed.

The **PORT NUMBER** for the **cab-4/ETH** is 5000. This port number must not be changed.

When you press the **TRY TO CONNECT** button, the software tries to establish a connection with the set parameters. The communication status is shown in the display field. If the sensor answers with its FIRMWARE ID, the set connection type can be accepted by pressing **ACCEPT SETTINGS**. You will then be returned to the **PARA** tab. If you get a **TIMEOUT** message, the software could not establish a connection to the sensor. In this case please check if the interface cable is correctly connected, if the sensor is supplied with power, and if the set parameters are correct. If a connection has been accepted by pressing **ACCEPT SETTINGS**, the software starts automatically with these settings when called the next time.

DISCONNECT disconnects the connection between sensor and PC. The software then switches to OFFLINE mode, where it is only possible to exchange parameters with a file on a storage medium.

Under **PANEL ID** a name can be entered that will be displayed at different points in the program window, and that will be recorded in different files (e.g. Record File) as well. With the input field **LANGUAGE** a language can be set with which the individual controls are displayed on the surface. This also applies to the help function that is actuated with the right mouse button.

 ATTENTION !	<p>Please note: The stable function of the interface is a basic prerequisite for measured value transfer from the PC to the sensor.</p> <p>Due to the limited data transfer rate through the serial RS232 interface only slow changes of the raw signals at the sensor front end can be observed in the graphic output window of the PC.</p> <p>For maintaining maximum switching frequency at the sensor data communication with the PC must be stopped (press the STOP button).</p>
---	--

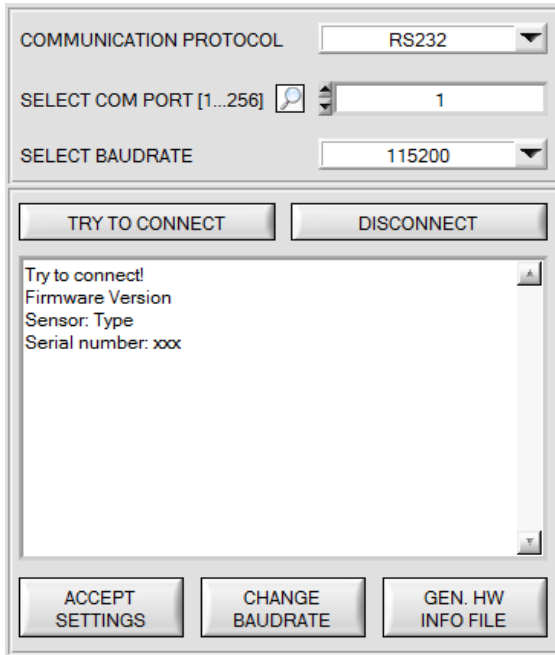

The baudrate for data transfer through the RS232 interface can be set by means of the **SELECT BAUDRATE** drop down menu and **CHANGE BAUDRATE** function field.

If the baudrate should be changed, a connection must first be established by clicking on **TRY TO CONNECT**. The **CHANGE BAUDRATE** button will then be active.

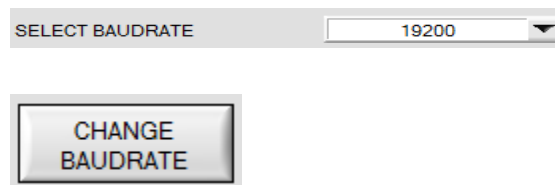

Now a new baudrate can be selected under **SELECT BAUDRATE**.

A click on **CHANGE BAUDRATE** sends the new baudrate information to the sensor.

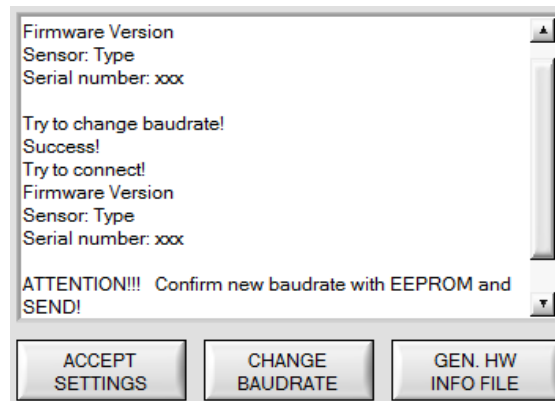

When the new baudrate information has been successfully sent, the sensor operates with the new baudrate. A window will pop up, prompting you to select **EEPROM** and then to press **SEND**. After a hardware reset the new baudrate only will be used when **EEPROM** and **SEND** have been pressed.

A click on **ACCEPT SETTINGS** saves the current interface settings, which will then be automatically set when the software is restarted.

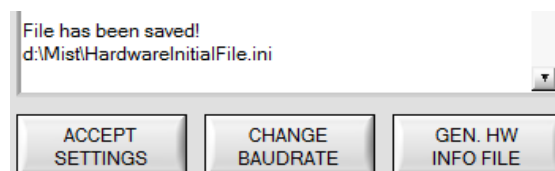

A click on the **GEN. HW INFO FILE** generates a file in which all the important sensor data are stored in encrypted form. This file can be sent to the manufacturer for diagnostic purposes.

2.2 Tab PARA1, PARA2, button SEND, GET, GO, STOP

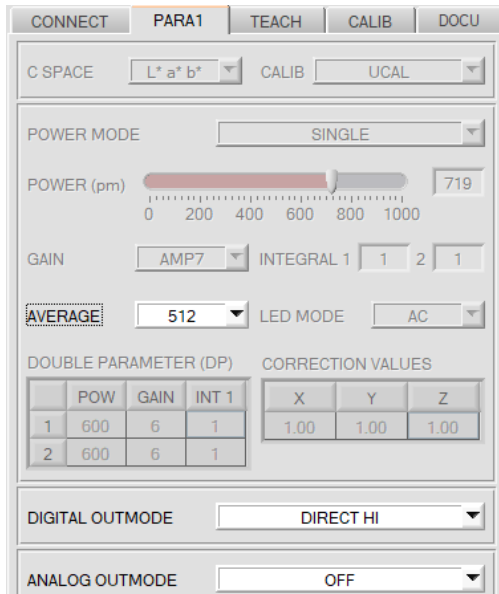

PARA1 and PARA2:

ATTENTION:

The **PARA2** tab appears only when using **SPECTRO-3-MSM-DIG** and **SPECTRO-3-MSM-SLE** series sensors. It does not appear for **SPECTRO-3-MSM-ANA** and **SPECTRO-3-MSM-SLA** series sensors.

Upon clicking **PARA1** or **PARA2**, there opens a view in which the sensor parameters are displayed.

Only the parameters that are needed for the respective **SPECTRO-3-MSM** series are visible.

Some parameters are active and can be changed if, for example, colors are taught after calibration. Others are grayed out and cannot be changed because they were preset during calibration, for example.

The meanings of the parameters are explained in the manual of the respective connected sensor.

A right-click on an active parameter (i.e. not grayed out) opens a window with brief information.

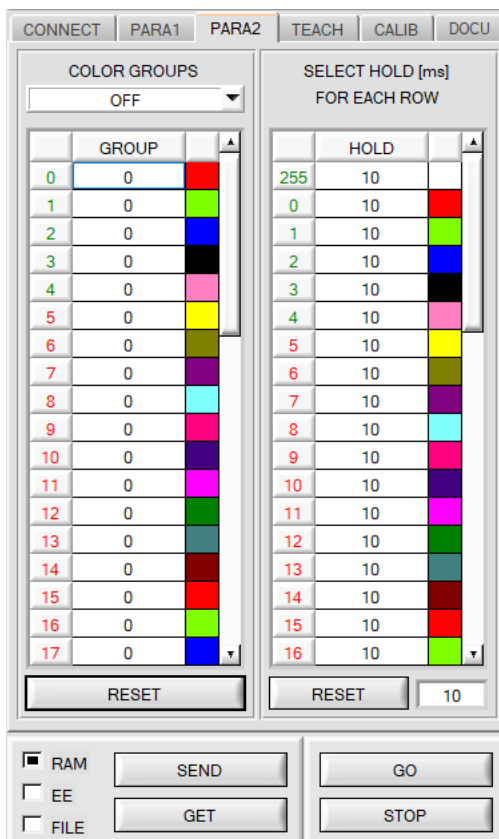

SEND [F9]:

By clicking the **SEND** button (or by shortcut key F9) all currently set parameters are transferred between PC and the sensor. The target of the respective parameter transfer is determined by the selected radio button (**RAM**, **EEPROM** or **FILE**).

GET [F10]:

The currently set values can be interrogated from the sensor by clicking on the **GET** button (or with shortcut key button F10). The source of data exchange is determined by the selected button (**RAM**, **EEPROM**, or **FILE**).

RAM:

The current parameters are read from the **RAM** of the sensor on pressing **GET**.

EEPROM:

The current parameters are read from its **EEPROM** upon pressing **GET**.

FILE:

After pressing **SEND**, the current parameters can be written to a selectable file on the hard disk. With **GET** parameters can be read from such a file. When the **SEND** or **GET** button is pressed, a dialog box opens for selecting the desired file.

GO [F11]:

Upon clicking this button, the data transfer from the sensor to the PC is started. The data are displayed in the display elements on the PC interface.

STOP [F12]:

Clicking this button ends the data transfer from the sensor to the PC.

AVERAGE

AVERAGE:

This function field is used for adjusting the number of scanning values (measurement values) over which the raw signal measured at the receiver is averaged. A higher **AVERAGE** default value reduces noise of the raw signals at the receiver unit and there will be a decrease of the maximal available switching frequency of the sensor.

DIGITAL OUTMODE

DIGITAL OUTMODE:

ATTENTION:

The DIGITAL OUTMODE parameter appears only for sensors of **SPECTRO-3-MSM-DIG**, **SPECTRO-3-MSM-SLE** and **SPECTRO-3-MSM-ANA** series.

It does not appear for sensors of the **SPECTRO-3-MSM-SLA** series.

This group of buttons offers the method of how to control the digital outputs.

OFF:

No digital signal is output. All the corresponding function fields are hidden.

DIRECT:

In this mode, a maximum of 5 teach colors or **COLOR GROUPS** can be taught for **SPECTRO-3-MSM-DIG** and **SPECTRO-3-MSM-SLE** sensors.

For **SPECTRO-3-MSM-ANA** sensors 2 colors can be taught. There are no **COLOR GROUPS**.

If in this row-by-row comparison the current color values correspond with the teach-in parameters entered in the teach table, this "hit" in the teach table is displayed as a color number (C-No.) and is sent **direct** to the digital outputs.

DIRECT HI:

If **DIRECT HI** is activated, the respective digital output is set to HIGH. If no color was detected, all digital outputs are set to LOW.

DIRECT LO:

If **DIRECT LO** is activated, the specially digital output is set to LOW, while the other ones are set to HIGH. If no color was detected, all digital outputs are set to HIGH.

BINARY HI:

If in the row-by-row comparison the current color values correspond with the teach-parameters entered in the color table, this "hit" in the color table is displayed as a color number (C-No.) and is provided at the digital outputs as a **bit pattern**.

In this mode a maximum of 31 teach colors or color groups can be taught with **SPECTRO-3-MSM-DIG** and **SPECTRO-3-MSM-SLE** sensors.

For **SPECTRO-3-MSM-ANA** sensors 3 colors can be taught. There are no **COLOR GROUPS**.

BINARY LO:

Same function as **BINARY HI**, but the **bit pattern** is output inversely.

ANALOG OUTMODE	XYZ
ANA OUT SIGNAL	U (0...10V)
ANA OUT	CONT
ZOOM	x1

ANALOG OUTMODE:

ATTENTION:

The **ANALOG OUTMODE** parameter appears only for sensors of **SPECTRO-3-MSM-ANA** and **SPECTRO-3-MSM-SLA** series.

It does not appear for sensors of **SPECTRO-3-MSM-DIG** and **SPECTRO-3-MSM-SLE** series.

This function field is used to determine the signals that the sensor provides at its analog outputs.

OFF: No analog signal is output.

X Y Z:

The tristimulus values **X, Y, Z** are acquired with 12 bit resolution.

The signals therefore may have values between 0 and 4095.

At the respective analog outputs these values are provided in a 0...+10V or 4...20mA range.

COLOR SPACE:

The color coordinates of the selected **C SPACE** are scaled to 12 bit and are output as a voltage from 0 to 10 V at the respective analog outputs.

Depending on the color coordinate, the analog output range is divided as follows:

x y Y from 0 to +1 (0V=0, 10V=1)

L* from 0 to +100 (0V=0, 10V=100)

a* from -150 to +150 (0V=-150, 10V=150)

u* from -788 to +724 (0V=-788, 10V=724)

u' from 0 to +4 (0V=0, 10V=4)

C* from 0 to +538 (0V=0, 10V=538)

b* from -150 to +150 (0V=-150, 10V=150)

v* from -154 to +164 (0V=-154, 10V=164)

v' from 0 to +0,6 (0V=-0, 10V=0,6)

h* from 0 to 360 (0V=0, 10V=360)

CS REF:

When input IN0 is set to HI, the current **C SPACE** color coordinates are saved as 5 V reference values.

This means that when the respective current **C SPACE** color value is equal to the reference value, 5 V will be output at the corresponding analog output. If the current value deviates from the reference value, this deviation is output at the corresponding analog output starting from 5 V and amplified by the **ZOOM** factor.

Example: **ZOOM** = x4, **a*(reference)** = 60, **a*(current)** = 70 → deviation = 10 (1 digit is approx. 2.44mV)

Output: 5 V+(10 digit * 32 (zoom) * 2.44 mV) = approx. 5.78 V.

The reference values are displayed in the graph window under the **C SPACE** tab.

Since the sensor only has one hardware input (IN0) this input possibility is not always available. If, for example, you select **ANA OUT = IN0 L→H**, the input already is used for a controlled output of the analog signal and is no longer available for **CS REF**.

Function fields that are not available will either be hidden or deactivated.

ANA OUT SIGNAL:

Here you set whether the analog signal should be output as voltage (0 ... 10V) or current (4 ... 20mA).

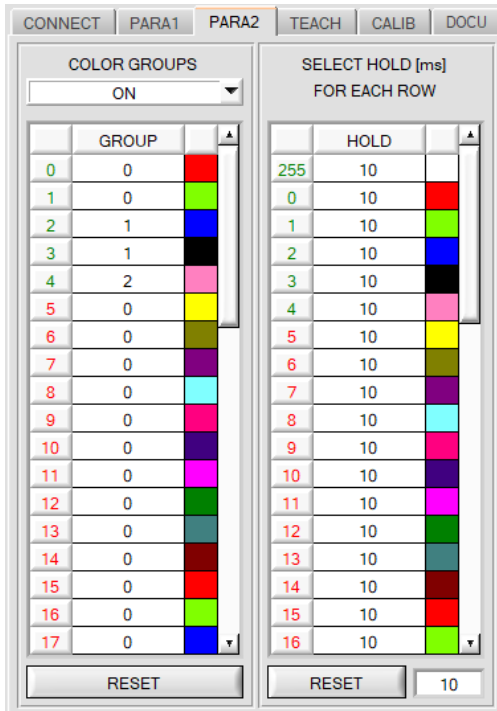

PARA2:

ATTENTION:

The **PARA2** tab appears only for sensors of **SPECTRO-3-MSM-DIG** and **SPECTRO-3-MSM-SLE** series. It does not appear for sensors of **SPECTRO-3-MSM-ANA** and **SPECTRO-3-MSM-SLA** series.

A click on **PARA2** opens a view where colors in the **TEACH TABLE** can be assigned to certain groups, and for each color and the error status an explicit **HOLD** time can be set.

Please note:

The sensor must be informed about the color groups and HOLD settings by pressing SEND.

COLOR GROUPS:

By means of the **GROUP** table individual rows can be assigned to a group.

In this example, **COLOR GROUPS** has been set to **ON**, i.e. group evaluation is activated.

Rows 0 and 1 have been assigned to group 0.

Rows 2 and 3 have been assigned to group 1, and row 4 to group 2.

A **GRP** display is shown under the **C-No:** display.

If, as in this example, row 3 is detected in the evaluation, this row and the corresponding group will be visualised.

The group number will be output through the outputs.

A total number of 48 different colors can be taught.

In evaluation mode **DIRECT HI** and **DIRECT LO** a maximum of 5 groups can be formed (group 0 to 4).

In evaluation mode **BINARY HI** and **BINARY LO** 31 groups can be formed.

All the cell values can be set to 0 by pressing **RESET**.
A double-click on the **GRP** display opens a larger display window.

HOLD in milliseconds [ms]:

The sensor operates with minimum scanning times in the magnitude of less than 100µs. This is why most of the PLCs that are connected to the digital outputs have difficulties with the safe detection of the resulting short switching state changes. Entering values in the table provides pulse lengthening at the digital outputs of the sensor system up to 100 ms. Each individual row can be assigned its own **HOLD** time.

When the **RESET** button is pressed, the complete table is set to the reset value indicated beside the **RESET** button.

Example:

Print marks are transported at a very high speed. The print marks are positioned in the sensor's range only for a very short time (milliseconds or even shorter). A minimum pulse of 10 ms is required for the reliable detection of a mark.

The background is taught to row 0, and the print mark to row 1. This is desirable because it allows the use of the **BEST HIT** evaluation mode.

If row 0 and row 1 overlap seamlessly, the sensor operates perfectly. The output is immediately activated and remains active at least for the time specified in the corresponding row.

If row 0 and row 1 do not overlap, the sensor detects an error at the transition from row 0 to row 1 (print mark), which immediately is sent to the output and remains active there at least for the **HOLD** time. An error inevitably would occur here if **HOLD** for the error state (255) was chosen too high, because the sensor only outputs a status change again after **HOLD** has elapsed (this may be the print mark, but it does not have to be).

It is absolutely necessary here to select a **HOLD** time of 0 for error state 255.

2.3 Tab TEACH

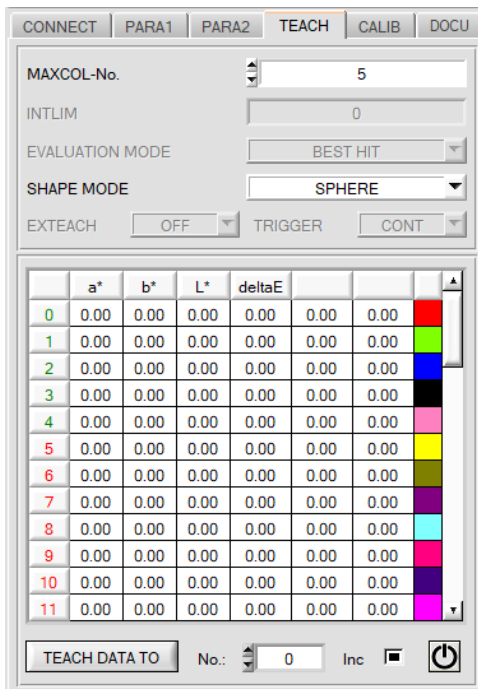

TEACH:

ATTENTION:

The **TEACH** tab appears only for sensors of **SPECTRO-3-MSM-DIG**, **SPECTRO-3-MSM-SLE**, and **SPECTRO-3-MSM-ANA** series.

It does not appear for sensors of **SPECTRO-3-MSM-SLA** series.

Clicking **TEACH** opens a view in which the **TEACH TABLE** and some parameters required for operation of the digital outputs are displayed.

Some parameters are active and can be changed, e.g. if colors are taught after calibration. Others are grayed out and cannot be changed because they were preset during calibration, for example.

The meanings of the parameters are explained in the manual of the respective connected sensor.

A right-click on an active parameter (i.e. not grayed out) opens a window with brief information.

The **TEACH TABLE** is organised in rows, i.e. the individual parameters for the teach colors are listed side by side in the respective row.

The sensor can work with up to 48 teach colors, depending on the sensor type. The number of the respective teach color is

shown in the left column of the table.

Only rows with a green number are used for evaluation by the sensor. The number of rows to be used is defined with **MAXCOL-No.**

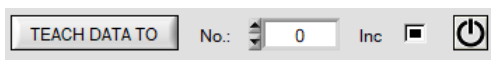

After pressing **TEACH DATA TO**, the currently displayed color coordinates and the brightness value are transferred to the line of the **TEACH TABLE** selected under **No.:**. In addition, a color

tolerance (**delta E**) is set. The tolerances, as well as the teach values, can be changed if necessary by double-clicking the respective field with the left mouse button (or by pressing F2) by entering numerical values with the PC keyboard.

If **Inc** is activated and the **TEACH DATA TO** button is pressed, an automatic incrementation (increase) of the input field **No.:** by 1 is performed, i.e. the next line in the **TEACH TABLE** is selected.

Pressing the **RESET** button resets the **TEACH TABLE** (RESET value = 0).



MAXCOL-No.:

This function field serves for setting the number of colors to be checked.

ATTENTION:

The **DIGITAL OUTMODE** tab appears only for sensors of **SPECTRO-3-MSM-DIG**, **SPECTRO-3-MSM-SLE** and **SPECTRO-3-MSM-ANA** series.

It does not appear for sensors of **SPECTRO-3-MSM-SLA** series.

With **OUTMODE = DIRECT HI** or **DIRECT LO** a maximum of 5 colors or color groups can be taught for **SPECTRO-3-MSM-DIG** and **SPECTRO-3-MSM-SLE** sensors.

For **SPECTRO-3-MSM-ANA** sensors 2 colors can be taught. There are no **COLOR GROUPS**.

With **OUTMODE = BINARY HI** or **BINARY LO** a maximum of 31 colors or color groups can be taught for **SPECTRO-3-MSM-DIG** and **SPECTRO-3-MSM-SLE** sensors.

For **SPECTRO-3-MSM-ANA** sensors 3 colors can be taught. There are no **COLOR GROUPS**.

If **COLOR GROUPS = ON** (for **SPECTRO-3-MSM-DIG** and **SPECTRO-3-MSM-SLE** sensors), the sensor can be taught up to 48 colors.

However, only 31 groups can be formed with **OUTMODE = BINARY** and 5 groups with **DIRECT HI** or **LO**.

The numerical value that is set here determines the current possible scan rate of the color sensor. If the number of colors to be checked is lower, the sensor operates faster. The numerical value that is defined here refers to the number of rows (starting with row 0) in the **TEACH TABLE** (→ TEACH tab).

SHAPE MODE

SHAPE MODE:

This function field is used to specify whether the color space coordinates (e.g. L^* a^* b^*) should be viewed as a block, cylinder, or sphere in space.

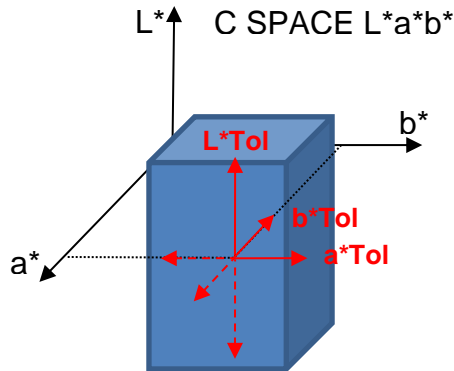

When viewed as a block, each color space coordinate has its own tolerance (a^*Tol , b^*Tol , L^*Tol).

The color distance ΔE is calculated from the color coordinates (a^* b^*).

A color is recognised if the current color space coordinates lie in the color block.

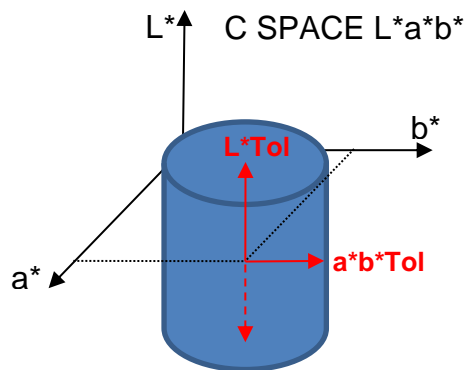

When viewed as a cylinder, the color coordinates (a^* b^*) have their own tolerance (a^*b^*Tol), and the brightness value (L^*) has its own tolerance (L^*Tol).

The color distance ΔE is calculated from the color coordinates (a^* b^*).

A color is recognised if the current color space coordinates lie in the color cylinder.

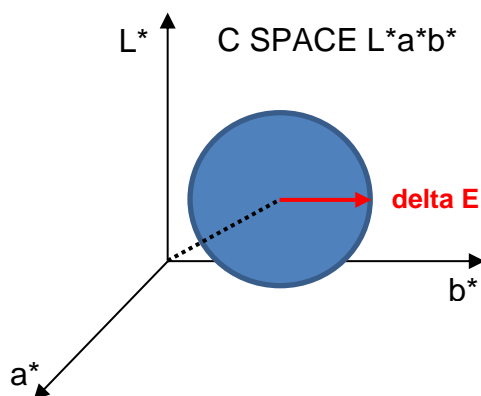

In sphere mode there only is one tolerance for the color space coordinates.

The color distance ΔE is calculated from the color space coordinates (L^* a^* b^*).

A color is recognised if the current color space coordinates lie in the color sphere.

2.4 Graphical display elements

Tab XYZ:

Display of the current raw signals (tristimulus values) **X, Y, Z** of the 3-fold receiver.

The LED **SAT** indicates if one of the channels is in saturation. In this case, it lights up red.

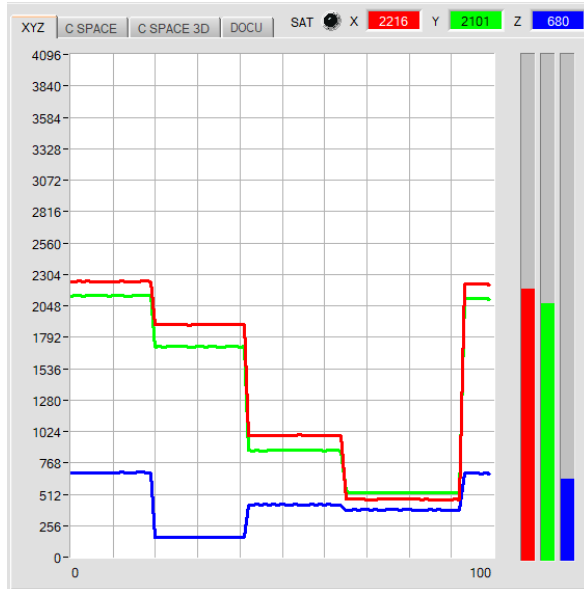

Tab C SPACE:

Line graph display of the color coordinates of the color space selected under **C SPACE**.

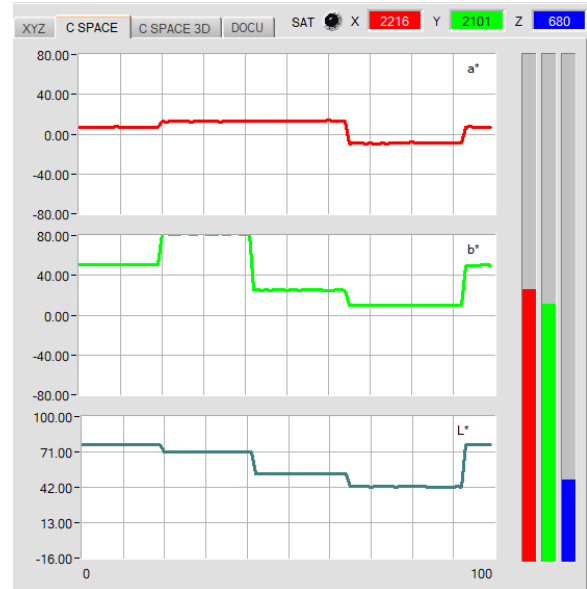

Tab C SPACE 3D:

Three-side view of the taught color in space.

The taught color space coordinates with their tolerances and the current color position are displayed. A three-side view in space was chosen to provide a clearer representation.

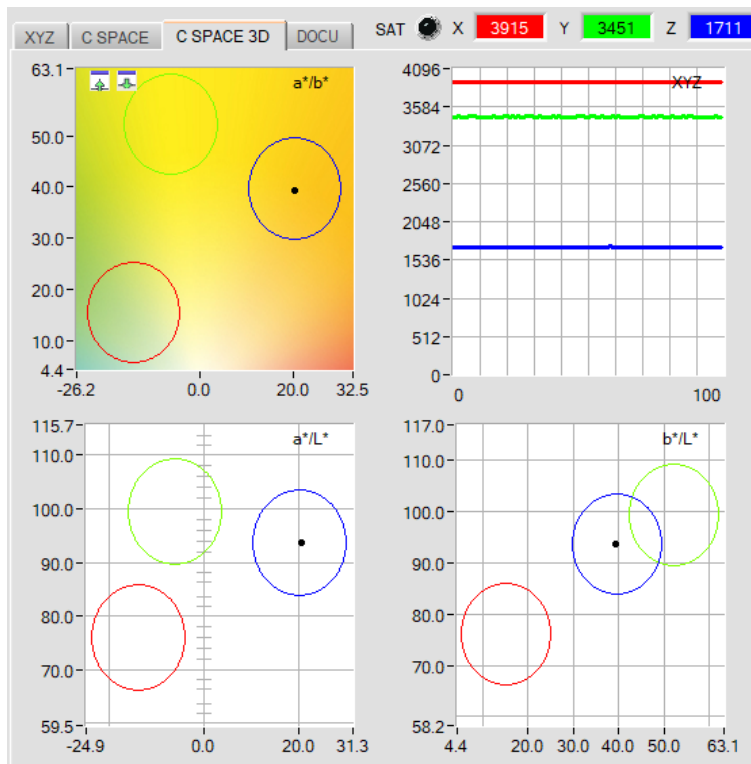

A left double-click in one of the graphs causes all the circles to be displayed in grey, only the circle with the recognised color is displayed in color.

A single left click returns to the standard view.

A left double-click in the XYZ graph starts an automatic zoom function.

A single left click closes this zoom function again

The graph with the color chart in the background can be zoomed in and out.

Tab DOCU:

This tab displays the **delta** values of the individual color coordinates for the respective color hit **C-No.**
 With the arrow keys you can scale the Y-axis of the graph.

Use the **RESET** button to set the graph to 0.

If the sensor does not detect a color (no color hit), the graphs are highlighted in red and the value -1 is displayed.

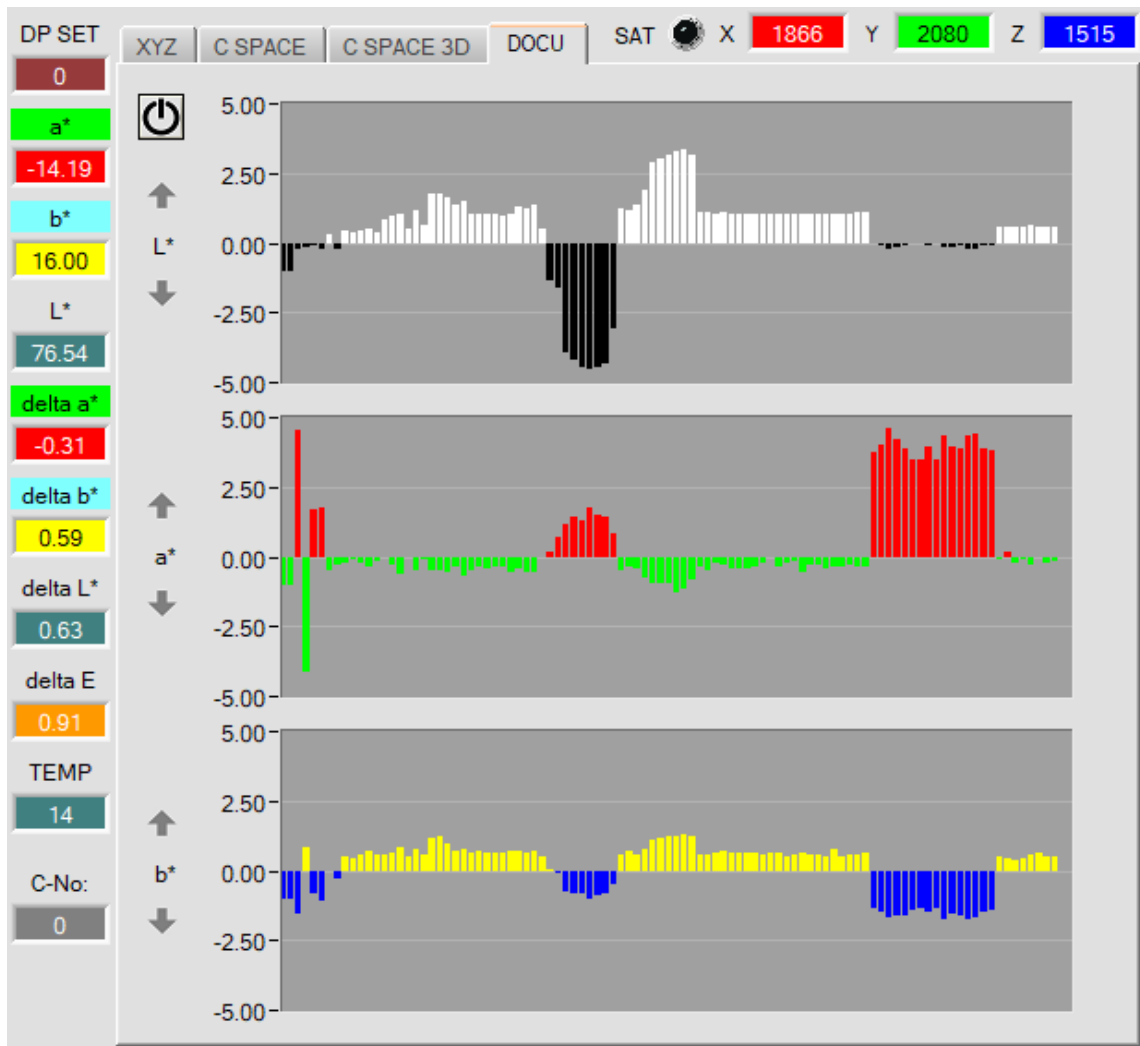

a*	u*	u'	C*	x
-12.98	-17.22	0.3196	35.17	0.2645
b*	v*	v'	h*	y
-8.18	-15.34	0.4736	14.43	0.3029
L*	L*	L*	L*	Y
67.63	54.01	50.10	32.31	0.2007

These numerical value displays show the color coordinates and brightness values that are calculated from the tristimulus values **X, Y, Z**. Calculation is performed as described in **C SPACE**.

delta a*	delta u*	delta x
0.10	0.01	0.0004
delta b*	delta v*	delta y
0.08	0.15	0.0097
delta L*	delta L*	delta Y
0.05	0.06	0.0007

These numeric value displays show the deviations of the individual color coordinates and of the brightness value of the current surface from the "color hit" (C-No:) in the **TEACH TABLE**. The values are calculated on the PC user interface and not in the sensor, and are only shown in these displays.

delta E
0.12

delta E:
The color deviation from the color hit is shown in this display.

C-No:
0

C-No:
The currently detected color number according to the entry in the **TEACH TABLE** is displayed in this numeric output field. The current detected color number is applied to the digital outputs as the corresponding bit pattern. A value of 255 means that none of the colors that have been learned has been detected.

GRP
0

GRP:
If there is a sensor connected, with which it is possible to form color groups, the detected color group is shown in this display. The currently detected group **GRP** and not **C-No:** is applied at the digital outputs as the corresponding bit pattern. A value of 255 means that none of the groups or colors that have been learned has been detected.

IN0

IN0:
This LED display visualises the status of input IN0. If 0 V is applied at the input, the LED is black. If 24 V is applied at the input, the LED is green. This display only is visible if the input is used.

TEMP
32

TEMP:
This display shows the temperature in the sensor housing. The display does **NOT** show degrees Celsius or Fahrenheit.

DP SET
0

DP SET:
With which **DOUBLE PARAMETER SET** the sensor is working currently is shown in this display.

Please note: The above-mentioned output fields are only updated when data transfer between PC and sensor is active (GO button pressed).

2.5 Tab CALIB

The sensors are factory calibrated. If the **CALIB** parameter is set to **FCAL** (Factory **CAL**ibration), the sensor operates with this factory calibration.

As an alternative the user can himself calibrate the sensor to different surfaces (**User CAL**ibration). If **CALIB=UCAL** is selected, the sensor operates with the calibration made by the user.

A click on **CALIB** will open the following window:

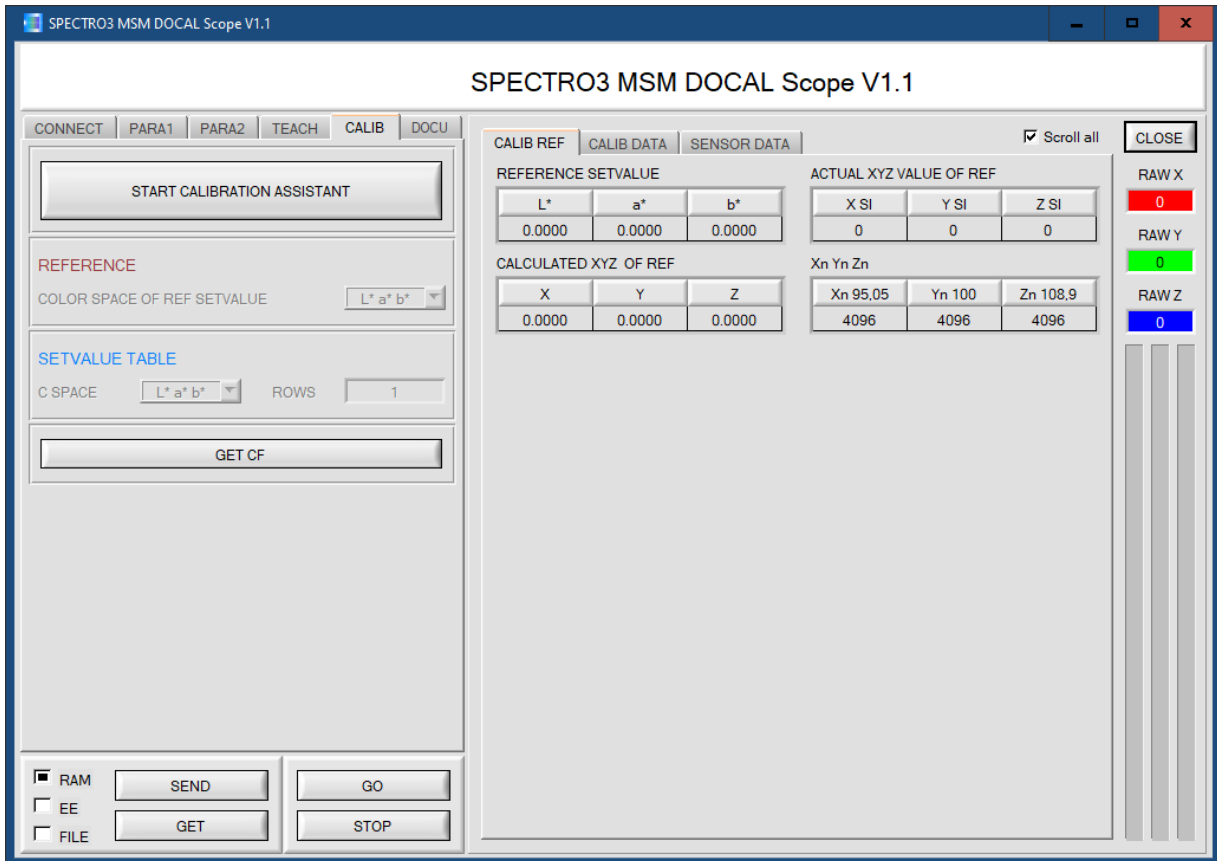

With **START CALIBRATION ASSISTANT** you can start an assistant that guides you through the calibration. The following three conditions must be met:

1. You need one reference plate. This is either the plate RAL 9003-P, RAL 9010-P, or RAL 9016-P.
2. You need different RAL color plates RAL from the *RAL CLASSIC* or *RAL DESIGN SYSTEM plus* series. These are available from the sensor supplier.
3. You need a file in which the L*a*b* values for the different RAL plates are stored. This file is also available from the supplier.

Upon pressing **GET CF**, the calibration factors that have been determined are displayed in the tab **SENSOR DATA**.

The individual tables, displays and display boxes for calculating the calibration factors are updated automatically during the calibration process. They cannot be changed and need not be paid any further attention.

2.6 Tab DOCU

Clicking **DOCU** opens a view in which, after pressing **CAPTURE DATA FRAME**, the **delta** values of the individual color coordinates for the respective color hit **C-No.** are displayed in three graphs.

With the arrow keys you can scale the Y-axis of the graph.

Use the **RESET** button to set the graph to 0.

If the sensor does not detect a color (no color hit), the graphs are highlighted in red and the value -1 is displayed.

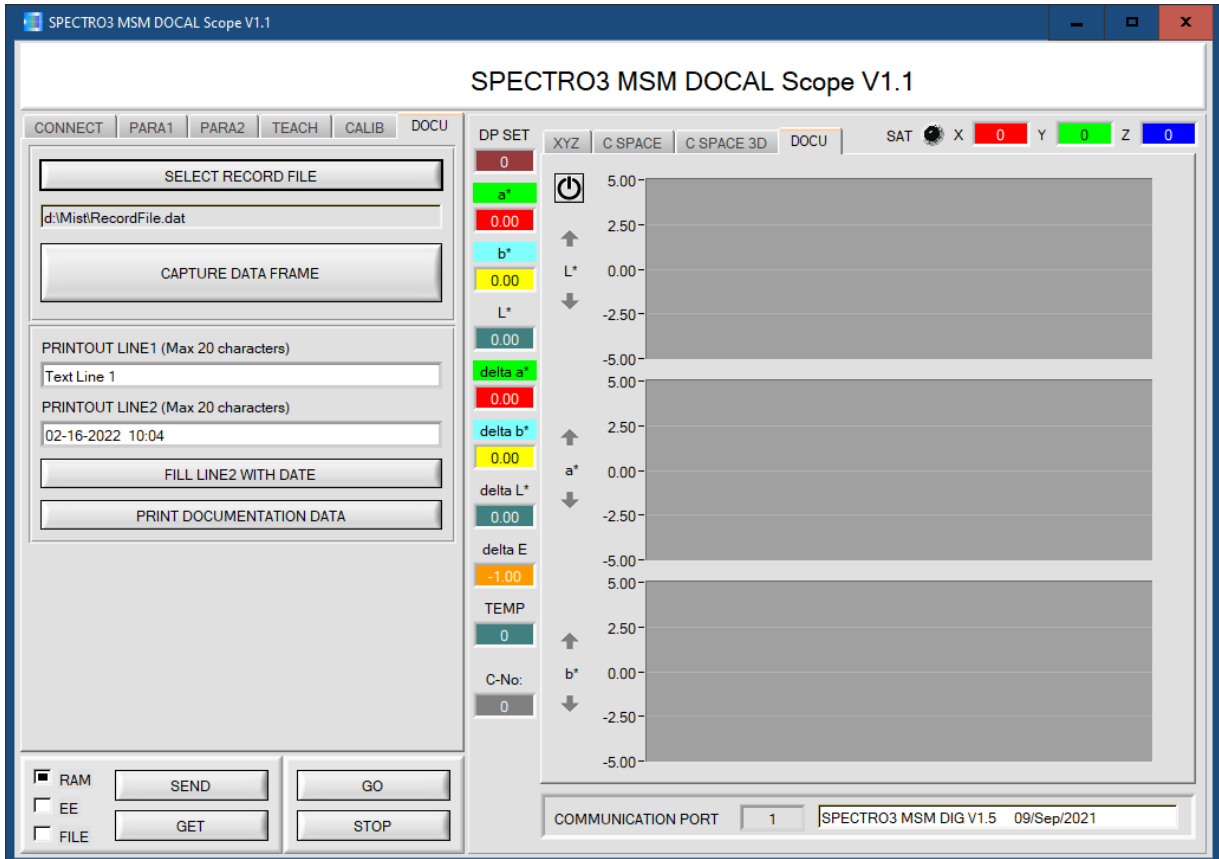

With the button **SELECT RECORD FILE** you select a file in which the **X, Y, Z** values, the color coordinates, the respective **delta** values as well as the color hit (**C-No.:**) and the sensor temperature can be stored.

The file is saved after pressing **CAPTURE DATA FRAME**.

It should be noted that the file is only regenerated after pressing **SELECT RECORD FILE**.

In any other case, the data is simply appended to the file displayed in the file path.

Even if the software has been restarted.

Pressing **PRINT DOCUMENTATION DATA** will output the current color coordinates, their **delta** values to the color match and the two text lines **PRINTOUT LINE1** and **PRINTOUT LINE2** to a printer. The button **FILL LINE2 WITH DATE** is used to enter the current date and time into **PRINTOUT LINE2**.

The data can also be output to a label printer. Please note that the labels must be at least 50mm wide and 30mm high.

If the labels are not output correctly, this can be optimized in the settings of the respective printer (printer-dependent).

3. Commissioning the label printer EOS2/300

We recommend the following label printer and accessories:

Printer	Accessories	Accessories
Company: cab Produkttechnik GmbH & Co. KG Model: cab EOS2/300 Item No. 5978202	Adhesive roll label Item No. 5780036 Material: TF Satin White Width x Height: 50x30mm	Thermal transfer ribbon Item No. 5556661

You can download drivers, documentation, additional software, etc. at the following link:
https://www.cab.de/en/marketing/label-printer/eos25/?ref=nav_lang

The installation of the software for the label printer is described in this manual.

Label printer and accessories can also be purchased from our company.

We have no experience with other printers and therefore cannot provide support.





3.1 Loading the roll adhesive label and the thermal transfer ribbon

See also Operator's Manual EOS2 / EOS5, subitem **Loading Material** (▷ 4 on page 12).

<https://www.cab.de/en/marketing/label-printer/eos25/#dokumentation> → Documentation → Operation Manuals

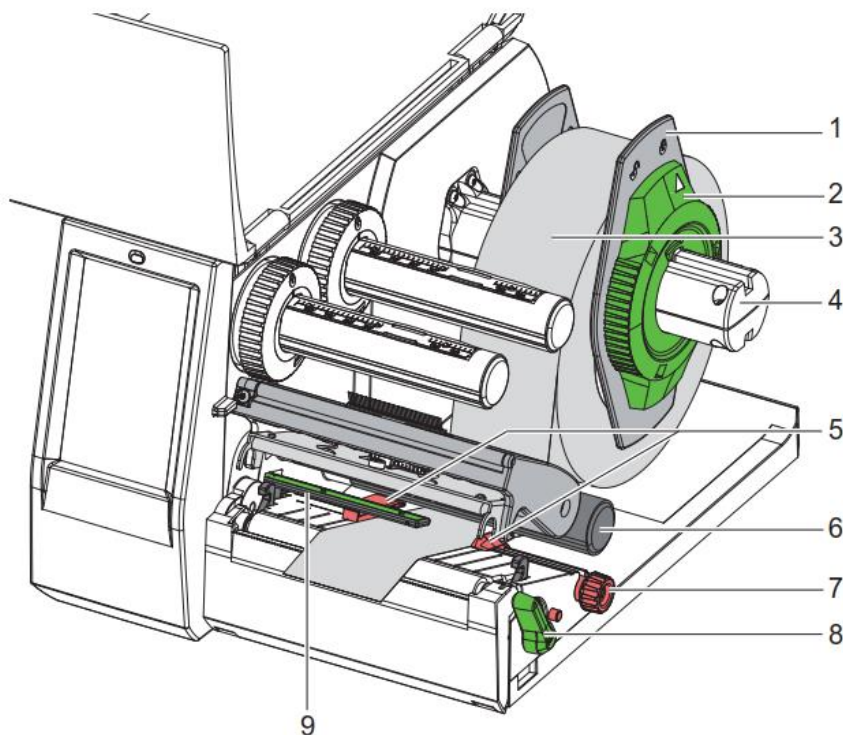
3.1.1 Loading media from roll



1. Turn ring (2) at the margin stop (1) counterclockwise, so that the arrow points to the symbol , and thus release the margin stop.
2. Remove the margin stop (1) from the roll retainer (4).
3. Load label roll (3) on the roll retainer (4) in such a way that the labels can be inserted into the printhead in the right position. The printing side of the labels must be visible from above.
4. Re-mount the margin stop (1) onto the roll retainer (4). Push the margin stop (1) to the roll (3) until the roll touches both margin stops and a clear resistance is encountered.
5. Turn ring (2) clockwise, so that the arrow (10) points to the symbol  and thus fix the margin stop (1) on the roll retainer (4).
6. Turn lever (8) counterclockwise to open printhead.
7. Position guides (5) by turning the knob (7) so that they are several millimeters wider than the material.
8. Position material below the roller (6) and guide it through the print unit.

Attention! Guide material through the print unit below the label sensor (9).

9. Move guides (5) closely to the edges of the material without clamping the material.
10. Adjust label sensor (see next page)
11. Press printhead retainer down and turn lever (8) clockwise to lock the printhead.

Adjusting the label sensor

Note!

When the printer is delivered the label sensor is positioned in the middle of the paper feed. Thus, the label sensor must only be adjusted if materials with the following characteristics are used:

- Material with reflex or cut-out marks, which are not in the middle.
- Multi-strip material with an even number of strips.
- Material with irregularly shaped labels.

If the labels recommended by us are used, an adjustment is not necessary.

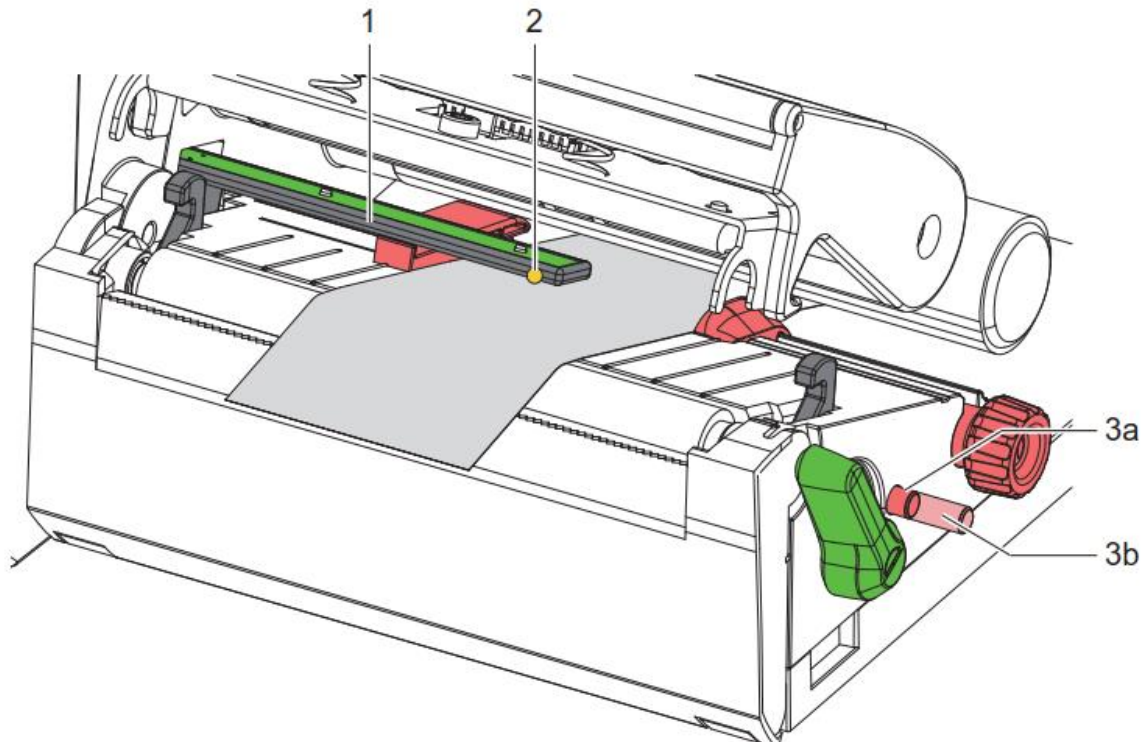

The sensor position (3) is marked with a yellow LED in the sensor retainer.

1. Open the printhead.
2. Bring knob (3) by pressing it into the setting position (3b).
3. Position the sensor holder (1) by turning the knob (3) so that the sensor (2) can detect the front edge of the label in the direction of paper flow or the reflex or cut-out mark.
4. Bring knob (3) by pressing it into the basic position (3a).

3.1.2 Loading transfer ribbon

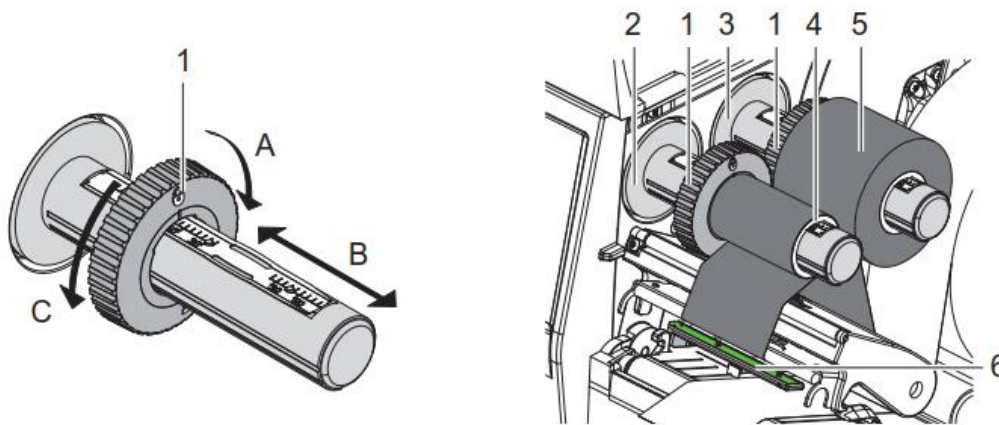

1. Clean the printhead before loading the transfer ribbon (see Operator's Manual EOS2, ▷ 6.3 on page 18).
2. Open the printhead.
3. Set guide (1) on the ribbon supply hub to the correct transfer ribbon width (Figure left):
 - Hold the hub and unlock the guide (1) by turning it in direction A..
 - Slide the guide (1) in direction B and adjust the guide to the ribbon width using the scale.
 - Hold the hub and lock the guide (1) by turning it in direction C.
4. Slide transfer ribbon roll (5) onto the ribbon supply hub (3) until it reaches the guide (1) so that the color coating of the ribbon faces downward when being unwound.

Note!

To rewind the ribbon a ribbon core (4) is needed that must be at least equal in width to the supply ribbon. When changing the transfer ribbon use the empty supply ribbon core for winding the next ribbon.

5. Adjust the position of the guide on the take-up hub to the width of the ribbon core (4) and push ribbon core on the take-up hub (2).
6. Guide the transfer ribbon through the printing unit as shown in Figure below.

ATTENTION!

Guide transfer ribbon over the label sensor (6).

7. Secure starting end of transfer ribbon to the transfer ribbon core (4) with adhesive tape. Regard counterclockwise rotation direction of the transfer ribbon take-up hub here.
8. Turn transfer ribbon take-up hub (2) counterclockwise to smooth out the feed path of the transfer ribbon.
9. Close the printhead.

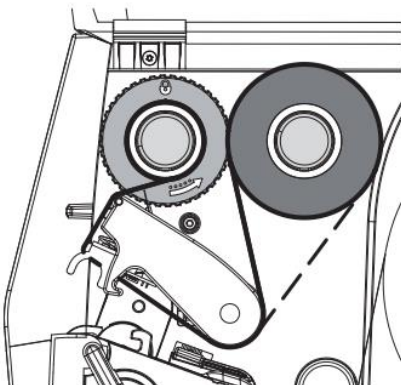

3.2 Installing the printer driver for Windows via USB cable

The following describes how to install the driver for the EOS2 label printer under Windows via the USB interface. See also PDF file „Configuration manual cab Label Printers“ under the following link:
<https://www.cab.de/en/marking/label-printer/eos25/#dokumentation>

1. Make sure that the label printer is switched off.
2. Exit all running programs
3. Connect the printer to the power supply and connect the A-B cable to your computer.
ATTENTION!
 Do not yet switch on the printer!
4. First download the printer driver "cab Windows Driver" to the hard disk of your PC. You can find the driver on the cab homepage under the following link:
<https://www.cab.de/en/marking/label-printer/eos25/#software>
 → Driver → cab Windows Driver → Save file
 The driver is then either in the download folder or in the path you may have selected. Unzip the "cab Windows Driver.zip" file.
5. Now turn on the printer. The Windows installation wizard is started automatically.
6. Start the application „PrnInst“ and follow the instructions on the screen. After successful installation, an icon for the label printer appears in the Windows system folder "Printers".

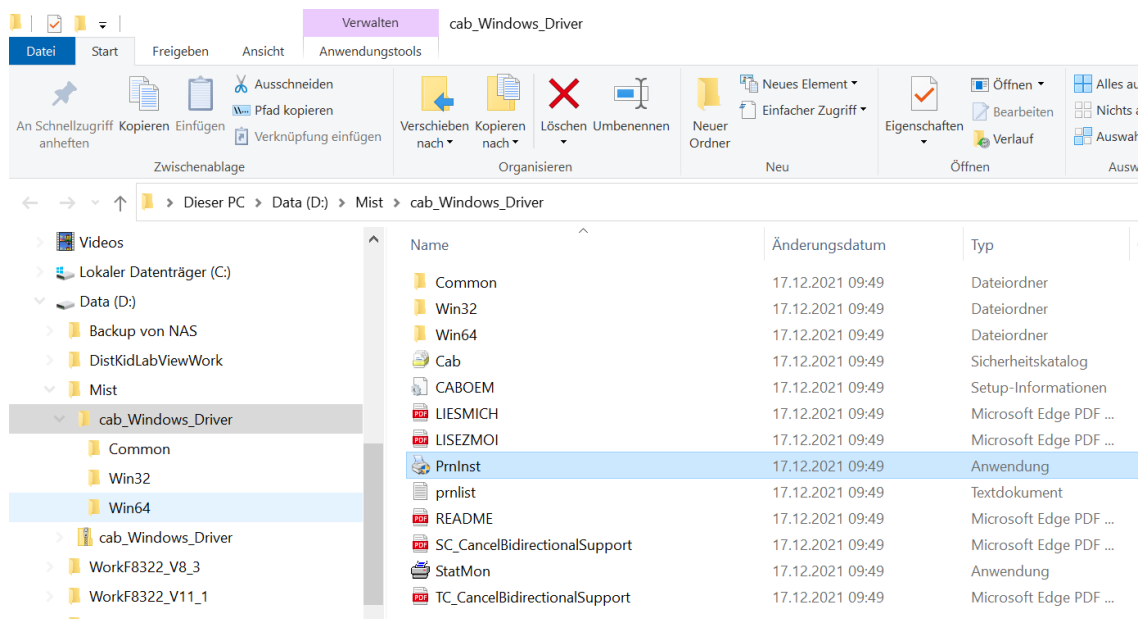

Confirm with "Next".

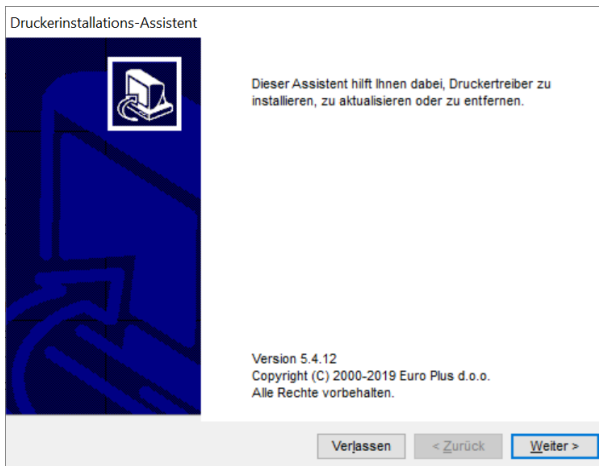

Select → Install printer driver.

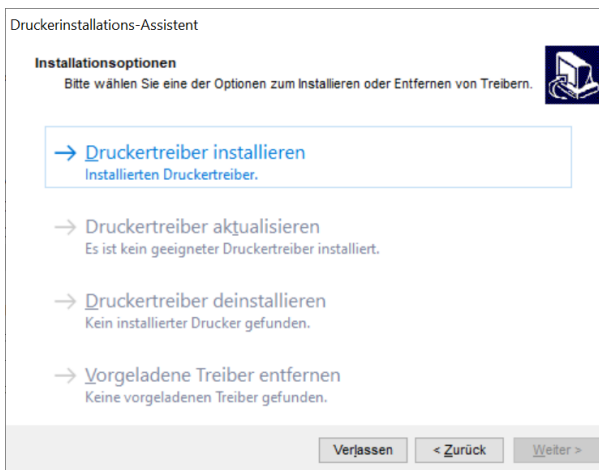

Select → USB interface.

The USB interface may have to be briefly disconnected and then reconnected.

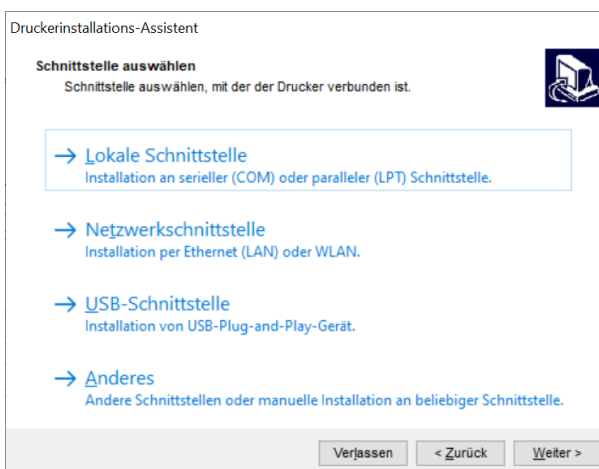

If the printer was recognized, you can still make printer settings here.
However, this is normally not necessary.
Press → Install.

Druckerinstallations-Assistent

Druckereinstellungen
Bitte wählen Sie vor der Installation Drucker-Optionen aus.

Druckername: CAB EOS2/300

Treiberversion: 5.3.03.7326

Portname: USB001

Wählen Sie die Sprache: Deutsch

Als Windows Standarddrucker verwenden

Verlassen < Zurück Installieren

Druckerinstallations-Assistent

Gerätetreiber wird installiert
Druckerinstallations-Assistent installiert den Gerätetreiber.

Gerätetreiber wird installiert.
CAB EOS2/300

Abbrechen

If the installation was successful, the following window appears.
Now press → Exit.

Druckerinstallations-Assistent

Zusammenfassung
Operation abgeschlossen. Bitte lesen Sie die folgende Zusammenfassung.

Installierte Drucker:
Installation von CAB EOS2/300 (ver. 5.3.3.7326) an Schnittstelle USB001
...erfolgreich.

Anderen Drucker installieren

Verlassen

3.3 Setting the printer properties

After the printer has been installed, it is displayed in the Windows system folder "Printers".

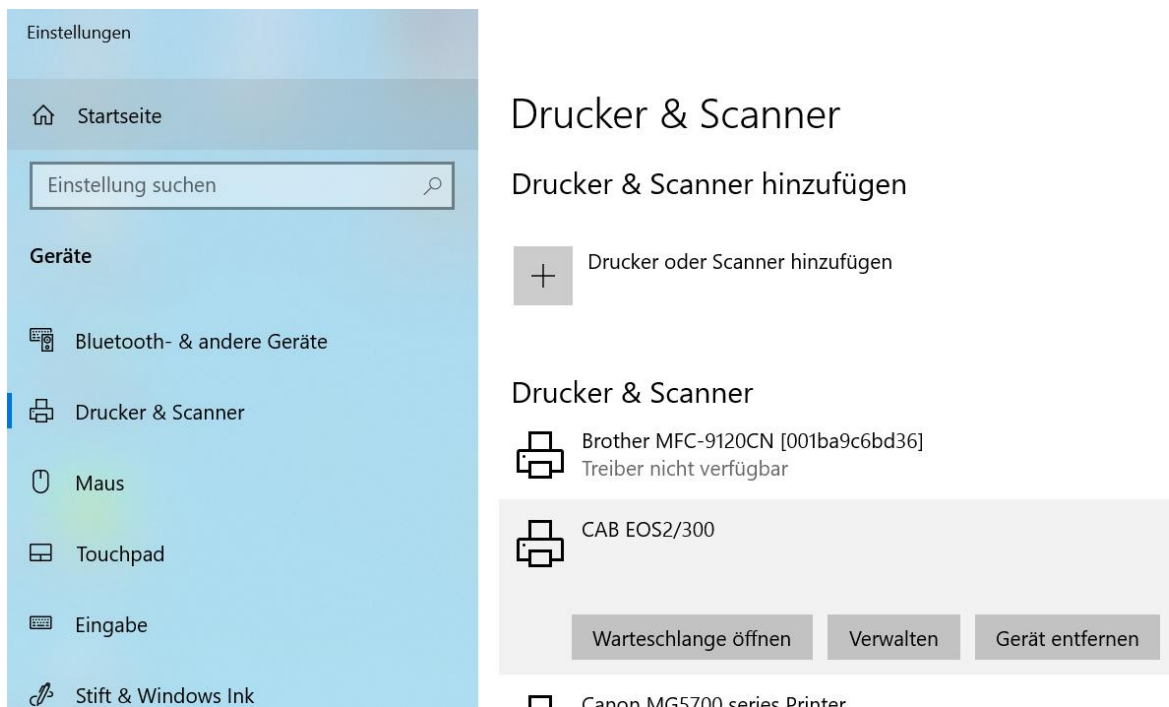

Press → Manage and then → Printer settings.
 For → Size, set 50.00 for Width and 30.00 for Height.
 This is the label size.
 Confirm with → Apply and → OK.

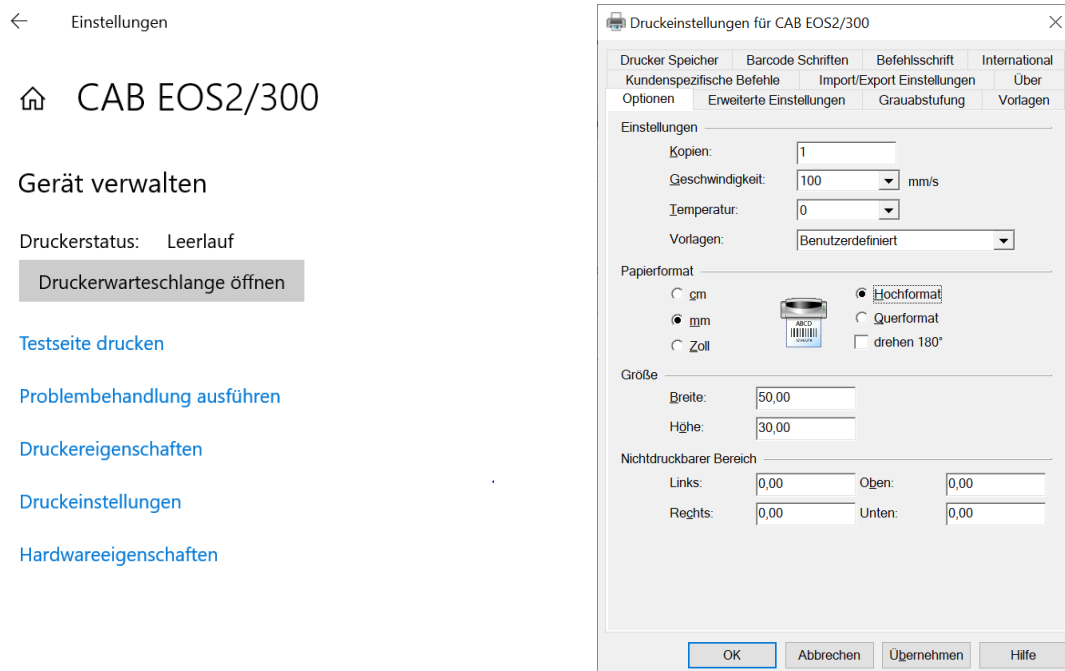

Now start the **SPECTRO3-MSM-DOCAL-Scope V1.1** and establish the connection to the sensor.
 In the **DOCU** tab, some data records can now be recorded.
 The **PRINTOUT LINE** fields can also be written.

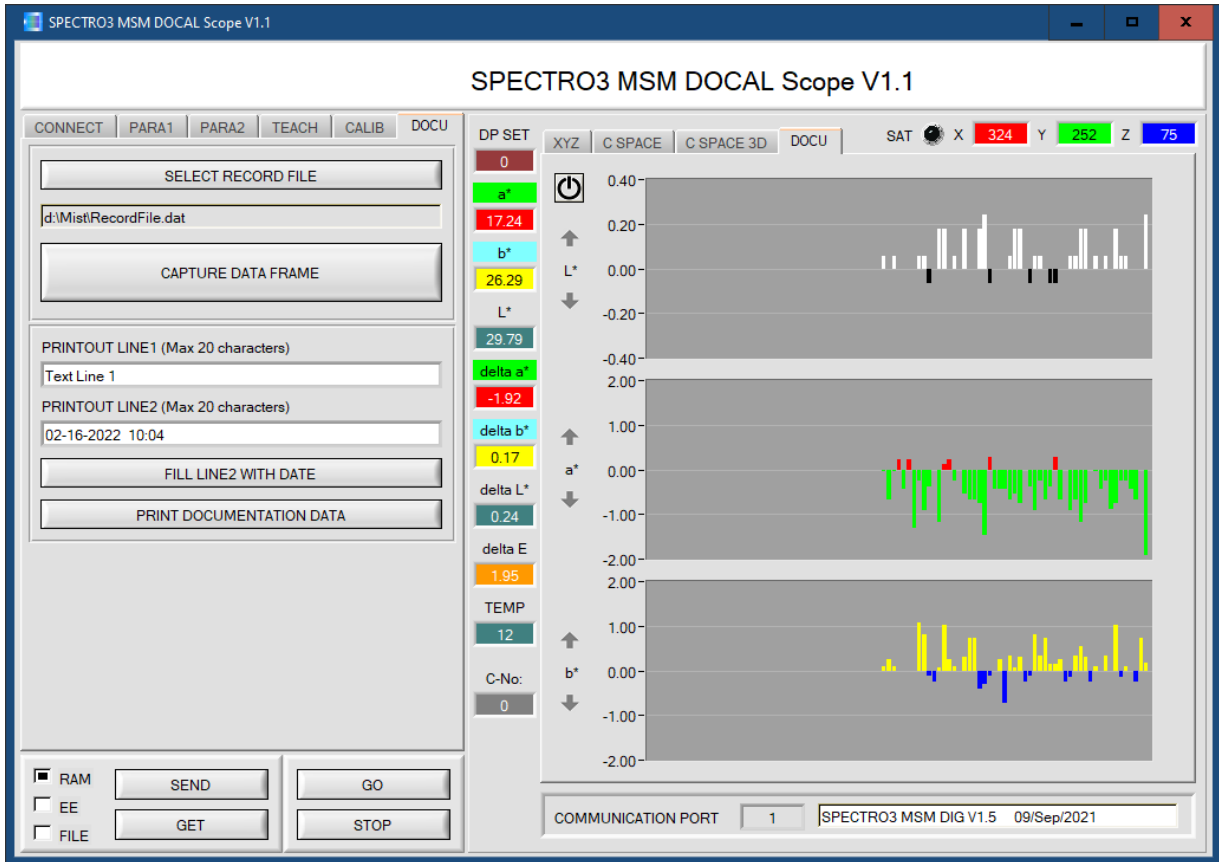

Then press → **PRINT DOCUMENTATION DATA**.
 Select the label printer "**CAB EOS2/300**" and confirm with **OK**.

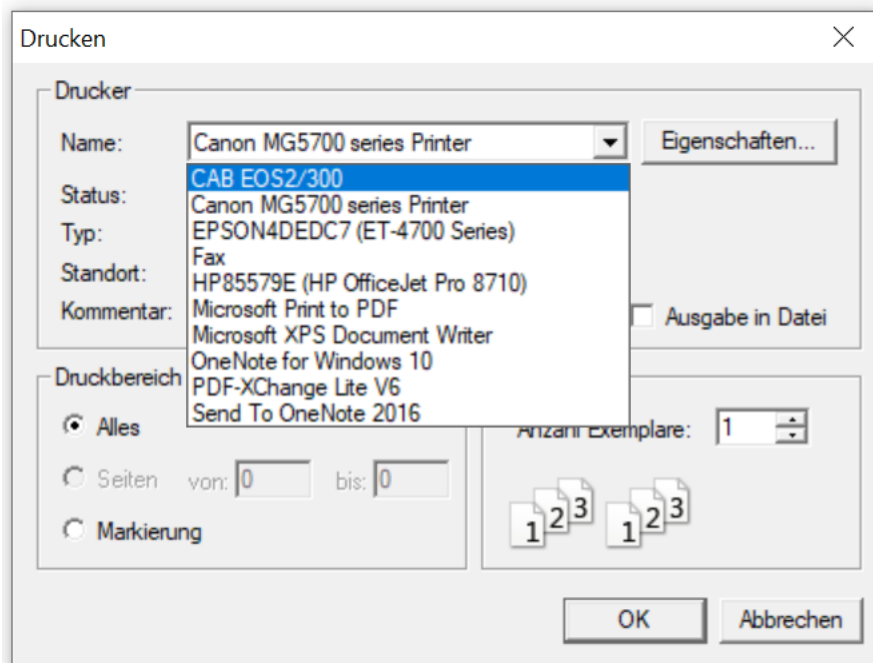

A successful printout looks like this:

